



Stripecoil

The passable but still floor-closing smoke apron

Product description

The passable and floor-closing smoke apron. Stripecoil is the optimum smoke protection for foot traffic areas and escape routes - designed for the temperature class according to DIN EN 12101 to D120 (heat resistance over 120 minutes at a test temperature of max. 600°C) and DH30 (heat resistance over 30 minutes at test temperature according to the unit temperature curve). A width of only 3 m is sufficient to allow about 200 people (including prams and wheelchairs) to pass through the passage per minute. A soft and yielding closing edge of the individual fabric strips helps to minimize the risk of injury. The smoke barrier closes without external energy thanks to the "Gravigen" drive system.

Type	Textile smoke apron	Closing cycles	1,000 cycles according to DIN EN 12101-1
Proof of usability	CE according to DIN EN 12101-1	Classification	DH 30 • D 120 • Classification according to DIN EN 12101-1
Fabric	Modutex 600 A2	Triggering	Approved hold-open system • To be provided on site
Verification	Z - 56. 429 - 916 • 0761-CPD-0060		
Closing direction	from top to bottom		

Constructive system design (Two winding shafts)

Fabric	System width	Drop length	t	h
Modutex 600 A2	> 1.4 m - ≤ 2.7 m	≤ 3.5 m	330 mm	270 mm
Modutex 600 A2	> 2.7 m - ≤ 15 m	≤ 3.5 m	330 mm	200 mm

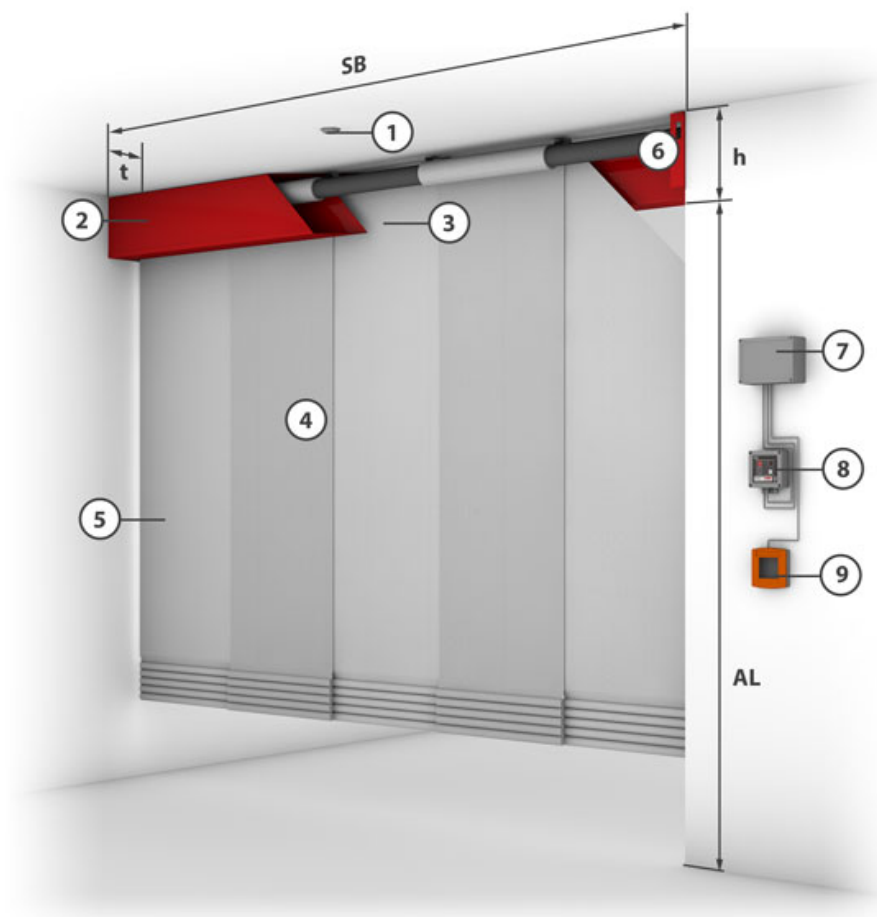

- 1 = Smoke detector
- 2 = Casing
- 3 = Side guide
- 4 = Fixing bracket
- 5 = Fabric
- 6 = Closing element
- 7 = Tubular motor
- 8 = Control module
- 9 = Control with operating unit
- 10 = Manual release

Constructive system design (One winding shaft)

Fabric	System width	Drop length	t	h
Modutex 600 A2	> 1 m - ≤ 1.8 m	≤ 3.5 m	190 mm	290 mm
Modutex 600 A2	> 1.8 m - ≤ 6 m	≤ 3.5 m	190 mm	225 mm

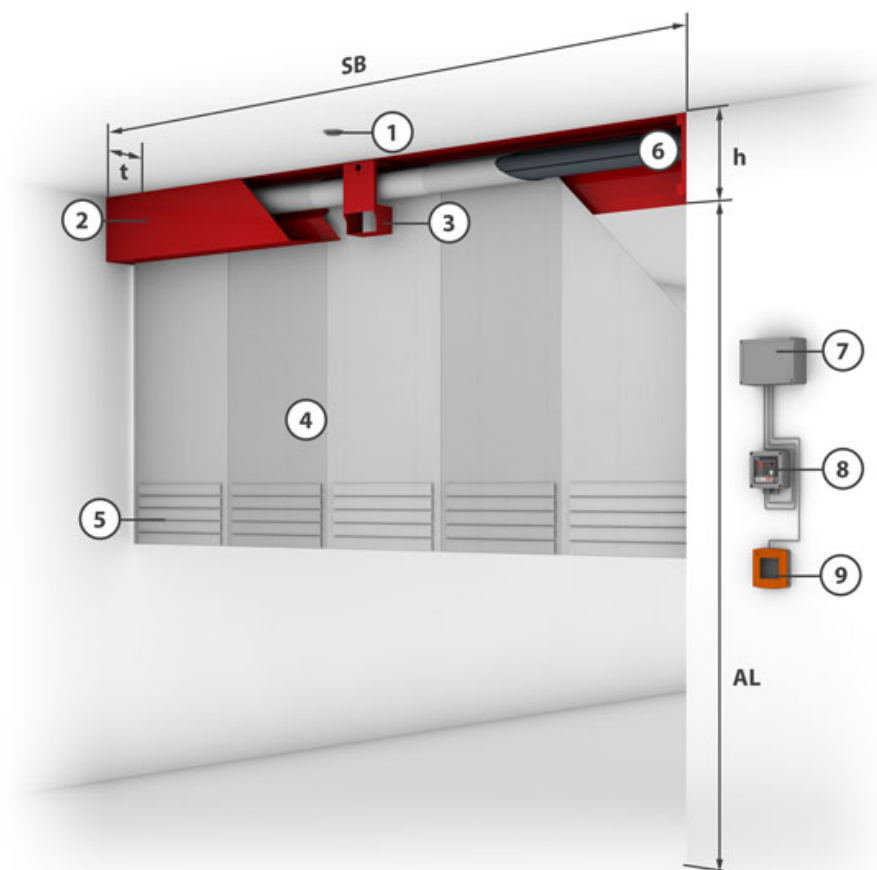

- 1 = Smoke detector
- 2 = Casing
- 3 = Side guide
- 4 = Fixing bracket
- 5 = Fabric
- 6 = Closing element
- 7 = Tubular motor
- 8 = Control module
- 9 = Control with operating unit
- 10 = Manual release

Closing strips

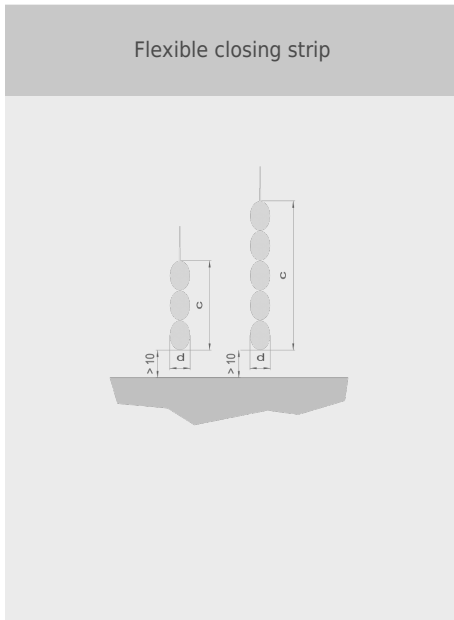

Casing installation options

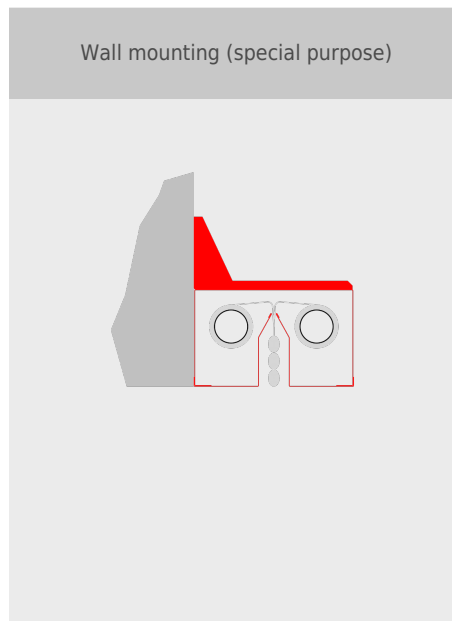
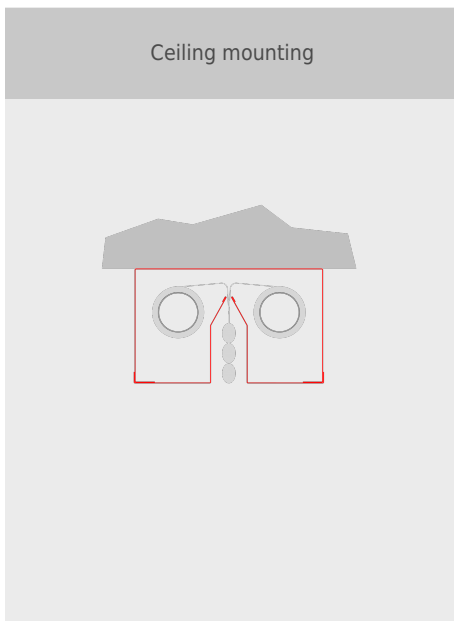

Casing

Multi-coil for wall mounting

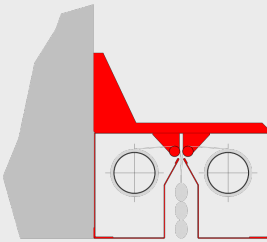

Multi-coil for ceiling (270)

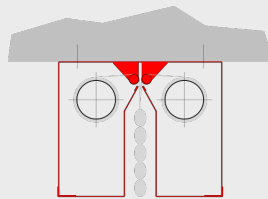

SB = ≤ 2,7 m

Multi-coil for ceiling (200)

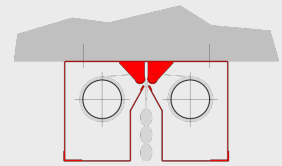

SB = > 2,7 m

Single-coil for wall mounting

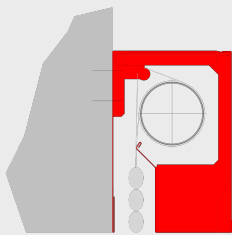

Single-coil for ceiling mounting

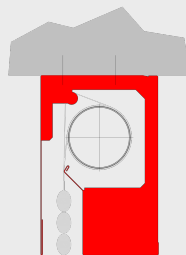

Guide rails

