

## Fibershield®-P

The premium textile fire protection curtain for high demands and large dimensions

### Product description

Ideal for efficient fire protection of large dimensions: The textile fire protection curtain Fibershield-P is approved for widths up to 10 m and drop lengths of up to 7.6 m. Larger dimensions are technically feasible. Different classifications can be achieved flexibly by using different types of fabric. The curtain can be moved with just one drive system. As standard, Fibershield-P is equipped with the tried and tested "Gravigen" drive, which closes without requiring an external power source. With numerous design variants, Fibershield-P offers plenty of scope for customer-specific solutions.

<b>Type</b>	Textile fire protection curtain	<b>Verification</b>	Z-6.60-2127 • UB III/B-07-010-1 • LP-1216.2/02 • UB III/08-033 • UB III/B-04-045 • UB 3.1/ 09-018 • UB 3.3/09-202 • UU IV/00-39-1 • 08/32309876 • 2011-Efectis-R0495
<b>Achievable protection goals</b>	EI - with fire load free zone • EI - with sprinklers	<b>Closing direction</b>	from top to bottom
<b>Proof of usability</b>	General technical approval (Z-6.60-2127)	<b>Fire resistance</b>	E 30 • E 60 • E 90 • EW 30 • EW 60 • classified according to DIN EN 13501-2
<b>Fabric</b>	Heliotex • Protex 1100.1 A2	<b>Closing cycles</b>	C2
<b>Fire load free zone</b>	Heliotex: EI 30/60/90min 20/30/50 cm • Protex: EI 30/60/90min 100/150/200 cm		

## Constructive system design (System drawing)

Classification	Fabric	System width	Drop length (AL)	t (mm)	h (mm)
EW 90	Heliotex EW	$\geq 0.8 \text{ m} - \leq 10 \text{ m}$	$\leq 2 \text{ m}$	190	250
EW 90	Heliotex EW	$\geq 0.8 \text{ m} - \leq 10 \text{ m}$	$\leq 6 \text{ m}$	235	290
E 90 / EW 30	Protex 1100.1 A2	$\geq 0.8 \text{ m} - \leq 1.6 \text{ m}$	$\leq 3.5 \text{ m}$	190	250
E 90 / EW 30	Protex 1100.1 A2	$\geq 1.6 \text{ m} - \leq 10 \text{ m}$	$\leq 3.5 \text{ m}$	190	200
E 90 / EW 30	Protex 1100.1 A2	$\geq 0.8 \text{ m} - \leq 10 \text{ m}$	$\geq 3.5 \text{ m} - \leq 6 \text{ m}$	190	250
E 90 / EW 30	Protex 1100.1 A2	$\geq 0.8 \text{ m} - \leq 10 \text{ m}$	$\geq 6 \text{ m} - \leq 7.6 \text{ m}$	235	290

(Special sizes on request - technically feasible up to dimensions 22 x 9m (Protex 1100.1 A2) or 12 x 6 m (Heliotex))

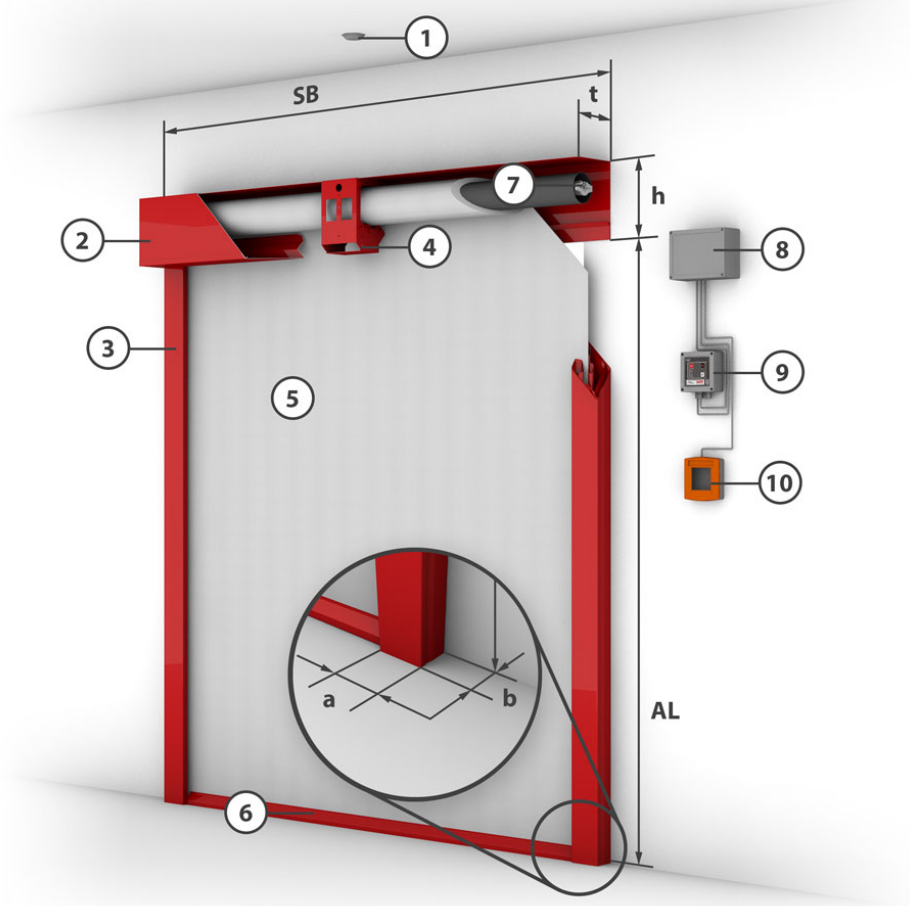

- 1** = Smoke detector    **2** = Casing    **3** = Side guide    **4** = Fixing bracket    **5** = Fabric    **6** = Closing element    **7** = Tubular motor  
**8** = Control module    **9** = Control with operating unit    **10** = Manual release

## Closing strips

standard

special

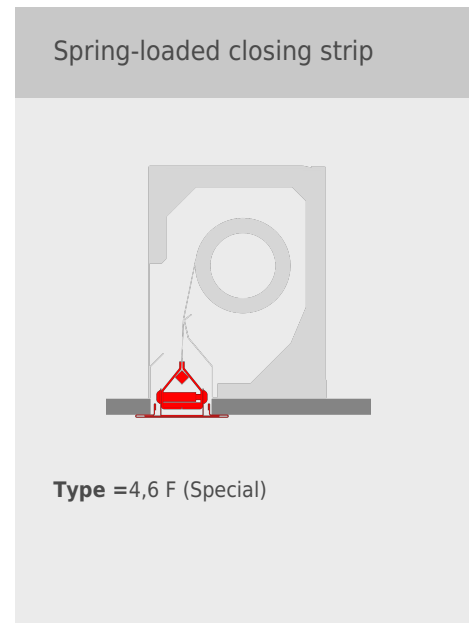
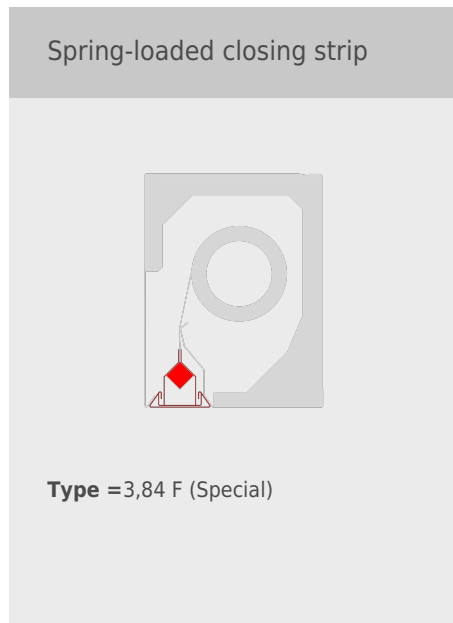
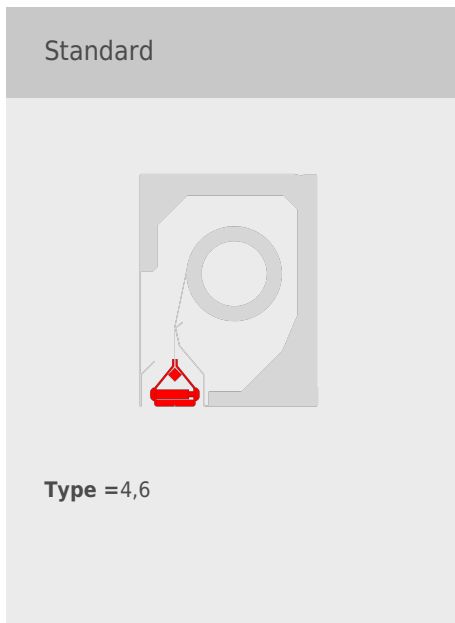

## Casing installation options

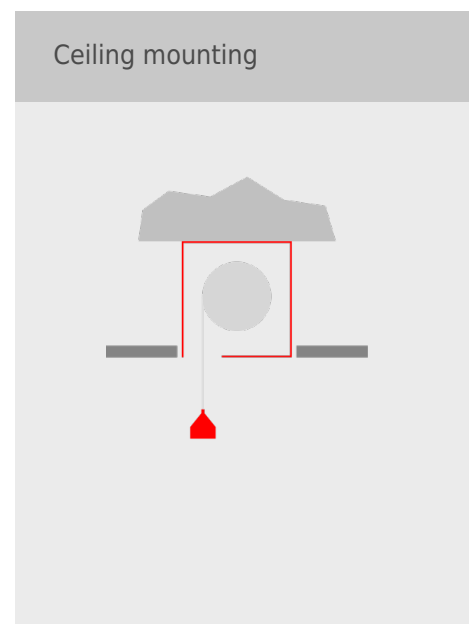
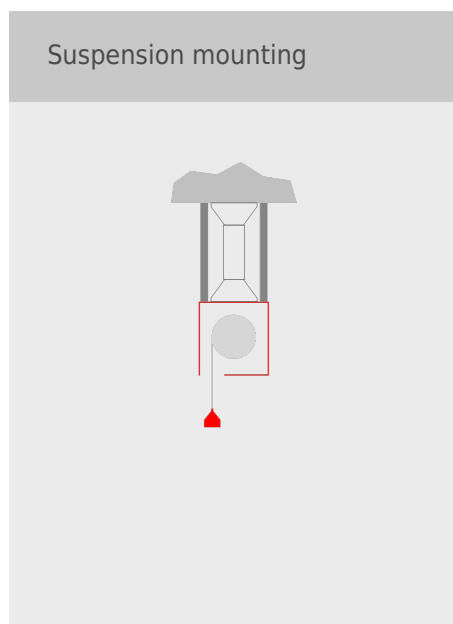
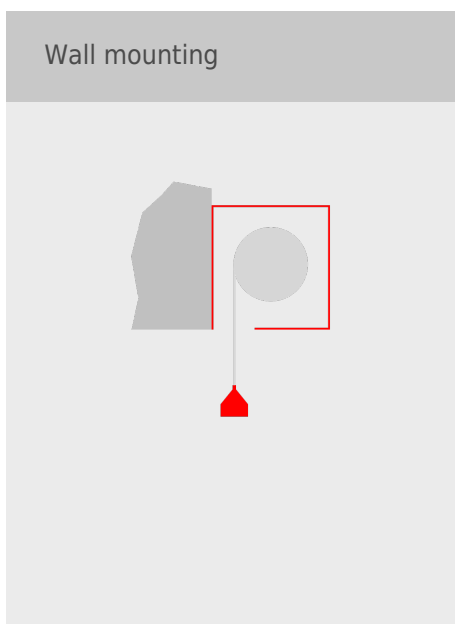

## Guide rails

Type 105 E (niche)

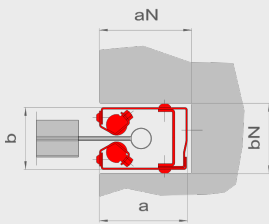

**a** = 105 mm   **b** = 74 mm  
**AL** = ≤ 6 m   **A** = ≤ 50 m<sup>2</sup>

Type 105 E (embrasure)

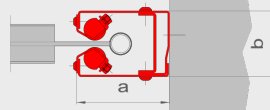

**a** = 105 mm   **b** = 74 mm  
**AL** = ≤ 6 m   **A** = ≤ 50 m<sup>2</sup>

Type 105 E(Wall)

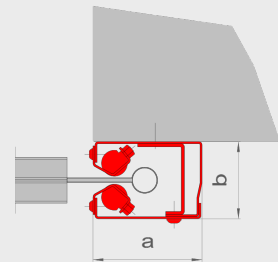

**a** = 105 mm   **b** = 74 mm  
**AL** = ≤ 6 m   **A** = ≤ 50 m<sup>2</sup>